

# OVERVIEW OF METAL HANDLES SUITABLE FOR DOORS

T.classic

T.lacq

T.acrylic

T.basic

T.effect<sup>+</sup>

FENIX NTM<sup>®</sup>

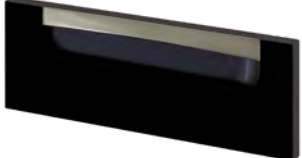
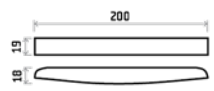

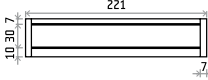
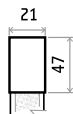
HANDLE PROFILE	T.classic	T.lacq	T.ærylic	T.basic	T.effect <sup>+</sup>	FENIX NTM <sup>®</sup>
E4	E4N / I4N	-	-	-	-	-
				<b>Handle specification:</b> Material: zinc alloy Surface: nickel satin brushed w x h (mm): 200 x 19		

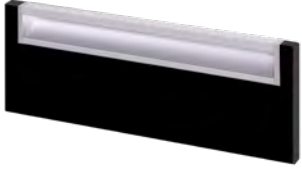
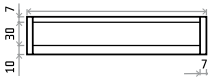
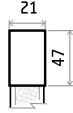
HANDLE PROFILE	T.classic	T.lacq	T.ærylic	T.basic	T.effect <sup>+</sup>	FENIX NTM <sup>®</sup>
E5	E5N / I5N	-	AE5N	BE5N	FE5N	XE5N
				<b>Handle specification:</b> Material: aluminium Surface: aluminium w x h (mm): 221 x 47		
				<p>The handle is not intended for the edge of the door</p>		

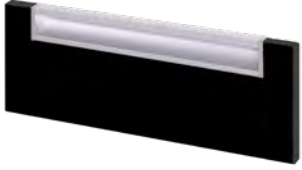
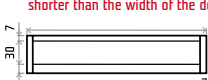
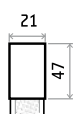
HANDLE PROFILE	T.classic	T.lacq	T.ærylic	T.basic	T.effect <sup>+</sup>	FENIX NTM <sup>®</sup>
E5K	E5K / I5K	-	AE5K	BE5K	FE5K	XE5K
				<b>Handle specification:</b> Material: aluminium Surface: aluminium The length of the handle varies depending on the width of the door		
		<p>The length of the handle is 60 mm shorter than the width of the door</p>				
		<p>The handle is not intended for the edge of the door</p>				

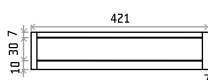
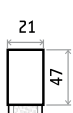
HANDLE PROFILE	T.classic	T.lacq	T.ærylic	T.basic	T.effect <sup>+</sup>	FENIX NTM <sup>®</sup>
E5K5	E5K5 / I5K5	-	AE5K5	BE5K5	FE5K5	XE5K5
				<b>Handle specification:</b> Material: aluminium Surface: aluminium The length of the handle varies depending on the width of the door		
		<p>The length of the handle is 100 mm shorter than the width of the door</p>				
		<p>The handle is not intended for the edge of the door</p>				

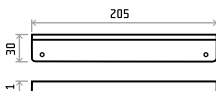
HANDLE PROFILE	T.classic	T.lacq	T.ærylic	T.basic	T.effect <sup>+</sup>	FENIX NTM <sup>®</sup>
E6	E6N / I6N	-	AE6N	BE6N	FE6N	XE6N
				<b>Handle specification:</b> Material: aluminium Surface: aluminium w x h (mm): 421 x 47		
				<p>The handle is not intended for the edge of the door</p>		

HANDLE PROFILE	T.classic	T.lacq	T.ærylic	T.basic	T.effect <sup>+</sup>	FENIX NTM <sup>®</sup>
E9	E9N / I9N	-	-	-	-	-
				<b>Handle specification:</b> Material: aluminium Surface: brushed stainless steel w x h (mm): 205 x 30		
						

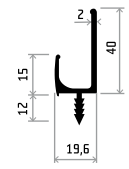
HANDLE PROFILE	T.classic	T.lacq	T. acrylic	T.basic	T.effect <sup>+</sup>	FENIX NTM <sup>®</sup>
E11	E11 / I11	-	-	-	-	-
				<p><b>Handle specification:</b>  Material: aluminium  Surface: aluminium  Length according to customer requirements  The handle can be painted (comaxit) in 14 selected RAL shades in matt finish (see last page of the document).</p>		

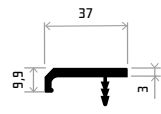
HANDLE PROFILE	T.classic	T.lacq	T. acrylic	T.basic	T.effect <sup>+</sup>	FENIX NTM <sup>®</sup>
EUK11	EUK11	QEUK11	AEUK11	BEUK11	FEUK11	XEUK11
				<p><b>Handle specification:</b>  Material: aluminium  Surface: powder coating (comaxit)  The handle can be painted (comaxit) in 14 selected RAL shades in matt finish (see last page of the document).</p>		

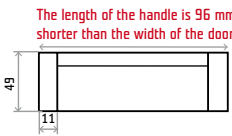
HANDLE PROFILE	T.classic	T.lacq	T. acrylic	T.basic	T.effect <sup>+</sup>	FENIX NTM <sup>®</sup>
EUK18	EUK18N	QEUK18	AEUK18	BEUK18	FEUK18	XEUK18
		 <p>The length of the handle is 96 mm shorter than the width of the door</p>		<p><b>Handle specification:</b>  Material: aluminium   Surface: anodised aluminium  The length of the handle varies depending on the width of the door  The handle can be painted (comaxit) in 14 selected RAL shades in matt finish (see last page of the document).  For design reasons, the handles are supplied including mounting on the door.</p>		

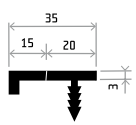
HANDLE PROFILE	T.classic	T.lacq	T. acrylic	T.basic	T.effect <sup>+</sup>	FENIX NTM <sup>®</sup>
E20	E20 / I20	QE20	AE20	BE20	FE20	XE20
				<p><b>Handle specification:</b>  Material: aluminium  Surface: brushed stainless steel  Available in a range of sizes:  147/197/247/297/397/447/497/547/597/697/797/  897/997/1197 [mm]</p>		

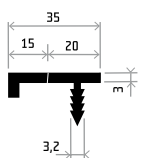
HANDLE PROFILE	T.classic	T.lacq	T. acrylic	T.basic	T.effect <sup>+</sup>	FENIX NTM <sup>®</sup>
E201	E201	QE201	AE201	BE201	FE201	XE201
				<p><b>Handle specification:</b>  Material: aluminium  Surface: brushed bronze  Available in a range of sizes:  147/197/247/297/347/397/447/497/547/597/697/797/  897/997/1197 [mm]</p>		

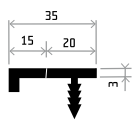
HANDLE PROFILE	T.classic	T.lacq	T. acrylic	T.basic	T.effect <sup>+</sup>	FENIX NTM <sup>®</sup>
E21	E21 / I21	QE21	AE21	BE21	FE21	XE21
				<p><b>Handle specification:</b>  Material: aluminium  Surface: black anodized brushed stainless steel  Available in a range of sizes:  147/197/247/297/397/447/497/547/597/697/797/  897/997/1197 [mm]</p>		

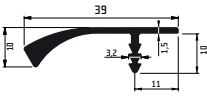
HANDLE PROFILE	T.classic	T.lacq	T. acrylic	T.basic	T.effect <sup>+</sup>	FENIX NTM <sup>®</sup>
E24	E24 / I24	QE24	AE24	BE24	FE24	XE24
				<p><b>Handle specification:</b> Available in a range of sizes:  Material: aluminium 147/197/247/297/397/447/497/547/  Surface: brushed stainless steel 597/697/797/897/997/1197 [mm]</p> <p>The handle is available in the more robust E24L version and in a length of 597 mm, e.g. for built-in refrigerators.</p>		

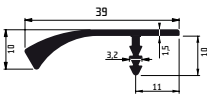
HANDLE PROFILE	T.classic	T.lacq	T. acrylic	T.basic	T.effect <sup>+</sup>	FENIX NTM <sup>®</sup>
E25	E25 / I25	QE25	AE25	BE25	FE25	XE25
				<p><b>Handle specification:</b> Available in a range of sizes:  Material: aluminium 147/197/247/297/397/447/497/547/  Surface: chrome 597/697/797/897/997/1197 [mm]</p> <p>The handle is available in the more robust E25L version and in a length of 597 mm, e.g. for built-in refrigerators.</p>		

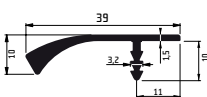
HANDLE PROFILE	T.classic	T.lacq	T. acrylic	T.basic	T.effect <sup>+</sup>	FENIX NTM <sup>®</sup>
E26	E26 / I26	QE26	AE26	BE26	FE26	XE26
				<p><b>Handle specification:</b> Available in a range of sizes:  Material: aluminium 147/197/247/297/397/447/497/547/  Surface: brushed graphite 597/697/797/897/997/1197 [mm]</p> <p>The handle is available in the more robust E26L version and in a length of 597 mm, e.g. for built-in refrigerators.</p>		

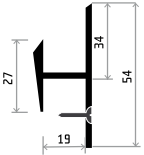
HANDLE PROFILE	T.classic	T.lacq	T. acrylic	T.basic	T.effect <sup>+</sup>	FENIX NTM <sup>®</sup>
E31	E31 / I31	QE31	AE31	BE31	FE31	XE31
				<p><b>Handle specification:</b>  Material: aluminium  Surface: brushed aluminium  The handle can be painted (comaxit) in 14 selected RAL shades in matt finish (see last page of the document).</p>		

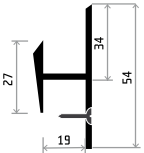
HANDLE PROFILE	T.classic	T.lacq	T. acrylic	T.basic	T.effect <sup>+</sup>	FENIX NTM <sup>®</sup>
E32	E32 / I32	QE32	AE32	BE32	FE32	XE32
				<p><b>Handle specification:</b>  Material: aluminium  Surface: dark brushed stainless steel  The handle can be painted (comaxit) in 14 selected RAL shades in matt finish (see last page of the document).</p>		

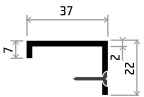
HANDLE PROFILE	T.classic	T.lacq	T. acrylic	T.basic	T.effect <sup>+</sup>	FENIX NTM <sup>®</sup>
E33	E33 / I33	QE33	AE33	BE33	FE33	XE33
				<p><b>Handle specification:</b>  Material: aluminium  Surface: brushed aluminium  The handle can be painted (comaxit) in 14 selected RAL shades in matt finish (see last page of the document).</p>		

HANDLE PROFILE	T.classic	T.lacq	T.àcrylic	T.basic	T.effect <sup>+</sup>	FENIX NTM®
E34	E34 / I34	QE34	AE34	BE34	FE34	XE34



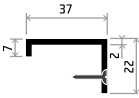

**Handle specification:**  
Material: aluminium  
Surface: dark brushed stainless steel  
The handle can be painted (comaxit) in 14 selected RAL shades in matt finish (see last page of the document).

HANDLE PROFILE	T.classic	T.lacq	T.àcrylic	T.basic	T.effect <sup>+</sup>	FENIX NTM®
E37	-	QE37	AE37	BE37	FE37	XE37



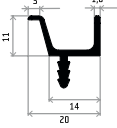

**Handle specification:**  
Material: aluminium  
Surface: nickel satin  
The handle can be painted (comaxit) in 14 selected RAL shades in matt finish (see last page of the document).

HANDLE PROFILE	T.classic	T.lacq	T.àcrylic	T.basic	T.effect <sup>+</sup>	FENIX NTM®
E38	-	QE38	AE38	BE38	FE38	XE38



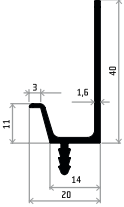

**Handle specification:**  
Material: aluminium  
Surface: nickel satin  
The handle can be painted (comaxit) in 14 selected RAL shades in matt finish (see last page of the document).

HANDLE PROFILE	T.classic	T.lacq	T.àcrylic	T.basic	T.effect <sup>+</sup>	FENIX NTM®
E39	-	QE39	AE39	BE39	FE39	XE39



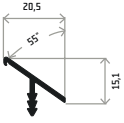

**Handle specification:**  
Material: aluminium  
Surface: anodised aluminium  
The handle can be painted (comaxit) in 14 selected RAL shades in matt finish (see last page of the document).

HANDLE PROFILE	T.classic	T.lacq	T.àcrylic	T.basic	T.effect <sup>+</sup>	FENIX NTM®
E40	-	QE40	AE40	BE40	FE40	XE40



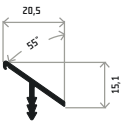



**Handle specification:**  
Material: aluminium  
Surface: nickel satin brushed  
The handle can be painted (comaxit) in 14 selected RAL shades in matt finish (see last page of the document).

HANDLE PROFILE	T.classic	T.lacq	T.àcrylic	T.basic	T.effect <sup>+</sup>	FENIX NTM®
E41	-	QE41	AE41	BE41	FE41	XE41

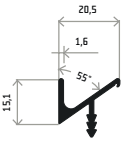





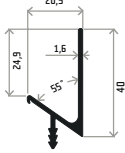

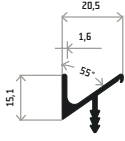
**Handle specification:**  
Material: aluminium  
Surface: anodised aluminium  
The handle can be painted (comaxit) in 14 selected RAL shades in matt finish (see last page of the document).

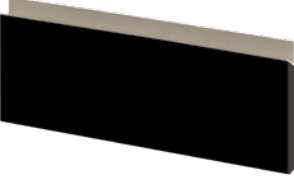
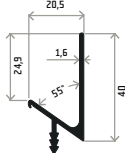
HANDLE PROFILE	T.classic	T.lacq	T.àcrylic	T.basic	T.effect <sup>+</sup>	FENIX NTM <sup>®</sup>
E42	-	QE42	AE42	BE42	FE42	XE42
			<b>Handle specification:</b> Material: aluminium Surface: anodised aluminium The handle can be painted (comaxit) in 14 selected RAL shades in matt finish (see last page of the document).			

HANDLE PROFILE	T.classic	T.lacq	T.àcrylic	T.basic	T.effect <sup>+</sup>	FENIX NTM <sup>®</sup>
E43	-	QE43	AE43	BE43	FE43	XE43
			<b>Handle specification:</b> Material: aluminium Surface: nickel satin The handle can be painted (comaxit) in 14 selected RAL shades in matt finish (see last page of the document).			

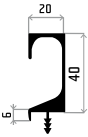
HANDLE PROFILE	T.classic	T.lacq	T.àcrylic	T.basic	T.effect <sup>+</sup>	FENIX NTM <sup>®</sup>
E44	-	QE44	AE44	BE44	FE44	XE44
			<b>Handle specification:</b> Material: aluminium Surface: nickel satin The handle can be painted (comaxit) in 14 selected RAL shades in matt finish (see last page of the document).			

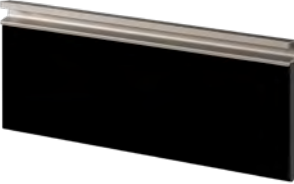
HANDLE PROFILE	T.classic	T.lacq	T.àcrylic	T.basic	T.effect <sup>+</sup>	FENIX NTM <sup>®</sup>
E45	E45 / I45	QE45	-	-	-	-
			<b>Handle specification:</b> Material: aluminium Surface: brushed aluminium The handle can be painted (comaxit) in 14 selected RAL shades in matt finish (see last page of the document).			

HANDLE PROFILE	T.classic	T.lacq	T.àcrylic	T.basic	T.effect <sup>+</sup>	FENIX NTM <sup>®</sup>
E46	E46 / I46	QE46	-	-	-	-
			<b>Handle specification:</b> Material: aluminium Surface: brushed stainless steel dark The handle can be painted (comaxit) in 14 selected RAL shades in matt finish (see last page of the document).			

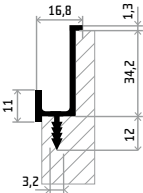
HANDLE PROFILE	T.classic	T.lacq	T.àcrylic	T.basic	T.effect <sup>+</sup>	FENIX NTM <sup>®</sup>
E47	-	-	AE47	BE47	FE47	XE47
			<b>Handle specification:</b> Material: aluminium   Surface: anodised aluminium The handle can be painted (comaxit) in 14 selected RAL shades in matt finish (see last page of the document). For design reasons, the handles are supplied including mounting on the door.			

HANDLE PROFILE	T.classic	T.lacq	T.ærylic	T.basic	T.effect <sup>+</sup>	FENIX NTM®
U6	U6N	-	AU6N	BU6N	FU6N	XU6N

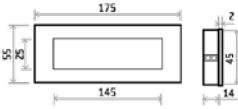
**Handle specification:**  
 Material: zinc alloy  
 Surface: sandblasted aluminium matt  
 w x h (mm): 175 x 55

HANDLE PROFILE	T.classic	T.lacq	T.ærylic	T.basic	T.effect <sup>+</sup>	FENIX NTM®
U7	U7N	-	AU7N	BU7N	FU7N	XU7N

**Handle specification:**  
 Material: zinc alloy  
 Surface: brushed stainless steel  
 w x h (mm): 175 x 55

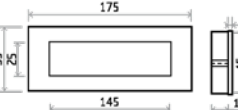
HANDLE PROFILE	T.classic	T.lacq	T.ærylic	T.basic	T.effect <sup>+</sup>	FENIX NTM®
U8	U8N	-	-	-	-	-

**Handle specification:**  
 Material: aluminium  
 Surface: brushed stainless steel  
 w x h (mm): 200 x 34,3

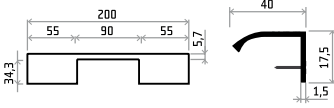
HANDLE PROFILE	T.classic	T.lacq	T.ærylic	T.basic	T.effect <sup>+</sup>	FENIX NTM®
U9	U9N	-	-	-	-	-

**Handle specification:**  
 Material: aluminium  
 Surface: brushed stainless steel  
 w x h (mm): 350 x 34,3

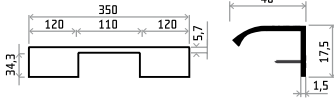
## Overview of RAL shades for powder coating (comaxit) in matt finish:

